

2MP Mini Fixed Bullet Network Camera

IPC2122SR3-PF40(60)-C



Key Features



Optics

- Day/night functionality
- Smart IR, up to 30m (98ft) IR distance
- Optical glass window with higher light transmittance
- IR anti-reflection window to increase the infrared transmittance
- 2D/3D DNR (Digital Noise Reduction)

Compression

- Ultra 265, H.265, H.264, MJPEG
- Triple streams
- 9:16 corridor format

Network

- ONVIF Conformance

Structure

- Wide temperature range: -35°C ~ 60°C (-31°F ~ 140°F)
- Wide voltage range of ±25%
- IP67
- 3-Axis

Specifications

	IPC2122SR3-PF40-C	IPC2122SR3-PF60-C			
Camera					
Sensor	1/2.7", 2.0 megapixel, progressive scan, CMOS				
Lens	4.0mm@F1.6		6.0mm@F1.6		
DORI Distance	Lens (mm)	Detect (m)	Observe (m)	Recognize (m)	Identify (m)
	4.0	60	24	12	6
	6.0	90	36	18	9
Angle of View (H)	91.2°		56.4°		
Angle of View (V)	47.9°		30.0°		
Angle of View (O)	95.9°		64.1°		
Adjustment angle	Pan: 0° ~ 360°		Tilt: 0° ~ 90°		Rotate: 0° ~ 360°
Shutter	Auto/Manual, 1 ~ 1/100000s				
Minimum Illumination	Colour: 0.005Lux (F1.6, AGC ON) 0Lux with IR on				
Day/Night	IR-cut filter with auto switch (ICR)				
S/N	>52dB				
IR Range	Up to 30m (98ft) IR range				
wavelength	850nm				
IR On/Off Control	Auto/Manual				
Defog	Digital Defog				
WDR	DWDR				
Video					
Video Compression	Ultra 265, H.265, H.264, MJPEG				
H.264 code profile	Baseline profile, Main Profile, High Profile				
Frame Rate	Main Stream: 2MP (1920*1080), Max 30fps; Sub Stream: 2MP (1920*1080), Max 30fps; Third Stream: D1 (720*576), Max 30fps				
Video Bit Rate	128 Kbps~16 Mbps				
9:16 Corridor Mode	Supported				
OSD	Up to 8 OSDs				
Privacy Mask	Up to 8 areas				
ROI	Up to 8 areas				
Motion Detection	Up to 4 areas				

Image	
White Balance	Auto/Outdoor/Fine Tune/Sodium Lamp/Locked/Auto2
Digital noise reduction	2D/3D DNR
Smart IR	Support
Flip	Normal/Vertical/Horizontal/180°/90°Clockwise/90°Anti-clockwise
Dewarping	N/A
HLC	Support
BLC	Support
Storage	
Network Storage	NAS(NFS)
Network	
Protocols	IPv4, IGMP, ICMP, ARP, TCP, UDP, DHCP, PPPoE, RTP, RTSP, RTCP, DNS, DDNS, NTP, FTP, UPnP, HTTP, HTTPS, SMTP, 802.1x, SNMP, QoS
Compatible Integration	ONVIF (Profile S, Profile T), API
Client	EZStation EZView EZLive
Web Browser	Plug-in required live view: IE9+, Chrome 41 and below, Firefox 52 and below
	Plug-in free live view: Chrome 57.0+, Firefox 58.0+, Edge 16+, Safari 11+
Interface	
Network	1 RJ45 10M/100M Base-TX Ethernet
Certifications	
Certifications	CE: EN 60950-1 UL: UL60950-1 FCC: FCC Part 15
General	
Power	DC 12V±25%, PoE (IEEE 802.3af)
	Power consumption: Max 6W
Dimensions (L × W × H)	157.3 × 63 × 62.4mm (6.2" × 2.5" × 2.5")
Net Weight	0.45kg (0.99lb)
Material	Front cover: plastic Body: metal Bracket: metal Bottom plate: metal
Working Environment	-35°C ~ 60°C (-31°F ~ 140°F), Humidity: ≤95% RH (non-condensing)
Storage Environment	-35°C ~ 60°C (-31°F ~ 140°F), Humidity: ≤95% RH (non-condensing)
surge protection	2KV
Ingress Protection	IP67
Reset Button	Supported

Dimensions

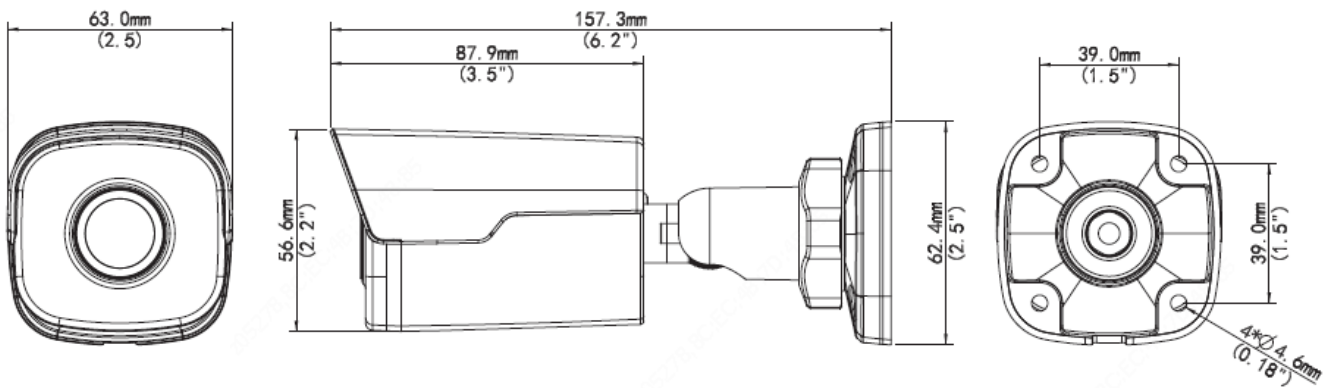

Accessories

TR-JB05-A-IN



TR-A01-IN



TR-UP06-B-IN



TR-UP06-C-IN



Zhejiang Uniview Technologies Co., Ltd.

Building No.10, Wanlun Science Park, Jiangling Road 88, Binjiang District, Hangzhou, Zhejiang, China (310051)

Email: overseasbusiness@uniview.com; globalsupport@uniview.com

<http://www.uniview.com>

©2019 Zhejiang Uniview Technologies Co., Ltd. All rights reserved.

*Product specifications and availability are subject to change without notice.